

徐工徐工 助您成功
XCMG FOR YOUR SUCCESS



XGC150-IA 履带起重机

CRAWLER CRANE



地址(Add): 中国江苏省徐州市金山桥经济开发区桃山路19号 邮编(Postal Code): 221004
No.19 Taoshan Road, Economic development zone of jinshanqiao, Xuzhou, Jiangsu Province, China
统一服务热线(Unified service hotline): 86 400-110-9999

销售热线Sales Hotline	服务热线Service Hotline
销售电话(Sale Tel): 86 0516-87892094	服务电话(Service Tel): 86 400-001-5678
销售传真(Sale Fax): 86 0516-87892074	服务传真(Service Fax): 86 0516-87892080
电子邮件(E-mail): jjyxd@xcmg.com	备件电话(Service Tel): 86 0516-87892086
服务质量投诉电话 (Quality Supervision Tel): 86 0516-87892587	备件传真(Service Fax): 86 0516-87892083



欢迎访问徐工商城
省心更省钱一站式



欢迎关注徐工履带起重机官方微信
1. 直接扫码“XCMG_xgj”增加好友
2. 查找公众账号“徐工履带起重机”
3. 直接扫描上方二维码

— 2020年02月版 —



CONTENTS

目录

P02	<ul style="list-style-type: none"> • 产品亮点 Product Highlights • 主要技术参数 The Main Technical Parameters • 详细介绍 Brief Introduction
P09	<ul style="list-style-type: none"> • 工况示意图 Working Mode Illustration • 主臂工况臂节组合 Boom Combinations • 主臂作业范围图 Boom Working Area • 主臂起重性能表 Boom Lifting Load Chart • 臂端单滑轮起重性能表 Boom Single Pulley Lifting Load Chart
P20	<ul style="list-style-type: none"> • 固定副臂臂节组合 Fixed Jib Combinations • 固定副臂作业范围图 Fixed Jib Working Area • 固定副臂起重性能表 Fixed Jib Lifting Load Chart • 主要零部件 Main parts • 工作条件及注意 Working conditions and Cautions

02

XGC150-IA 履带起重机 XGC150-IA CRAWLER CRANE

P03-P03	产品亮点 Product Highlights
P04-P04	主要技术参数 The Main Technical Parameters
P05-P08	详细介绍 Brief Introduction

01 运输、拆装优化设计

Optimized design of transport and assembly/disassembly

- 配置齐全的自拆装系统（选配），可轻松实现：后配中央配重自拆装、履带梁自拆装和主臂底节臂自拆装。
Fully equipped self-assembly/disassembly system (Optional) can easily achieve: rear counterweight self-assembly/disassembly, track frame self-assembly/disassembly, and boom base self-assembly/disassembly.
- 最大单件运输重量控制在29吨内，运输宽度不超过3米，能够满足全球无障碍运输要求。
Largest single unit transport weight is controlled within 29t, transport width not more than 3m, so as to meet the transport requirement of global accessibility.
- 臂架套装运输设计，最大化利用运输空间，节省运输成本。
Tower jib and fixed jib can be three-piece integrated transport, and transport design of inserted boom sections, maximize the use of transport space, and save transport costs.

02 结构设计更优化

More optimized structural design

- 上车采用大箱型结构设计，承载能力强、重量轻、刚性好。
Superstructure is a large box-type structural design, with heavy load bearing capacity, light weight, and good rigidity.
- 副起升卷扬置于主臂底节臂，转台布置宽松，维护保养方便。
Auxiliary hoisting winch is placed in boom base, with relaxed arrangement for turntable, easy maintenance.

主要技术参数 The Main Technical Parameters

项目Items	单位Unit	数值Data
最大额定起重量 Max. rated lifting capacity	主臂工况Main boom	t 150
	固定副臂工况Fixed jib	t 22
	臂端单滑轮工况 Boom single top	t 13.5
最大起重力矩 Max. load moment	t·m	840
尺寸参数 Size parameters	主臂长度Boom length	m 16 ~ 76
	主臂变幅角度Boom luffing angle	° -3 ~ 80
	固定副臂长度Fixed jib length	m 13 ~ 31
	主臂与固定副臂夹角Angle between boom and fixed jib	° 15、30
速度参数 Speed parameters	臂端单滑轮长度 Boom single pulley arm length	m 1.4
	起升机构最大单绳速度(空载、第五层) Hoist winch max. single line speed (no load, at 5th layer)	m/min 120
	主臂变幅机构最大单绳速度(空载、第三层) Boom luffing winch max. single line speed (no load, at 3rd layer)	m/min 2 × 45
	最大回转速度Max. swing speed	r/min 1.7
发动机 Engine	最高行驶速度Max. travel speed	km/h 1.3
	型号Model	- 上柴SC9DK270G3
	额定功率及转速 Rated output power and speed	kW/rpm 200/1800
	排放标准 Emission standard	- 非道路国 III
整机质量(基于150吨吊钩, 48t转台配重, 6t车身配重, 16m基本主臂) Total vehicle weight (with 150t hook block, 48t turntable counterweight, 6t car-body counterweight, and 16m basic boom)		t 133
平均接地比压Mean ground pressure		MPa 0.093
爬坡能力Grade ability		% 30
运输状态单件最大质量Max. transport weight of single unit		t 36.2(可拆解至29t)
运输状态单件最大尺寸(长×宽×高)Max. transport dimension of single unit(L×W×H)		m 11.0×3.0×3.3

注：1.行走速度与回转速度是基于水平光滑坚实地面，机重136t的理论计算值。
2.本公司保留对技术参数的更新更改权，如有变更恕不另行通知。
Pictures and data in this catalog will change with the update and modification of products, so please take the actual vehicle as reference.

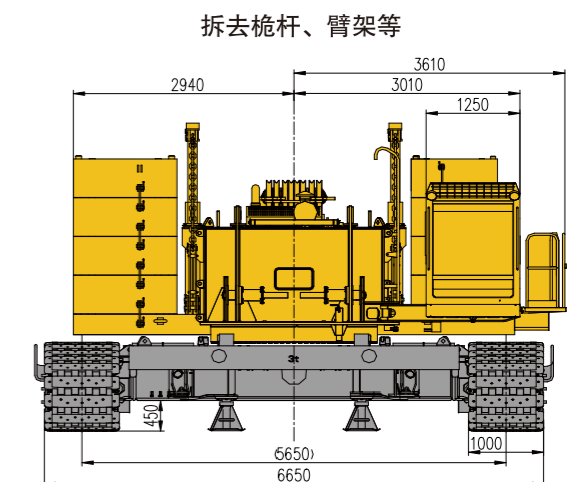
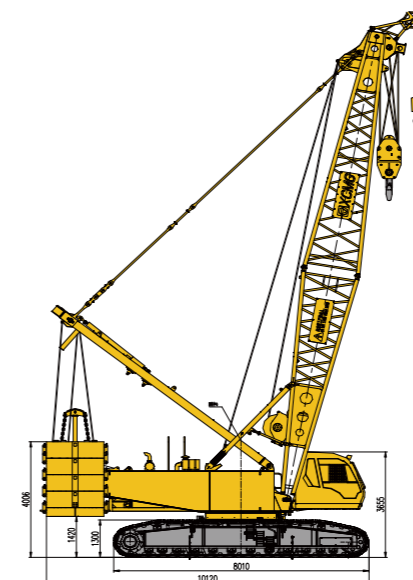

详细介绍 Brief Introduction

上车 / Crane Superstructure

发动机 / Engine

采用上柴发动机, 额定功率200kW, 额定转速为1800rpm, 最大输出扭矩1200N·m。排放符合GB20891-2014非道路第三阶段排放标准。

Shanghai diesel engine, rated output 200kW, rated speed 1800rpm, max. output torque 1200N.m, emission in compliance with GB20891-2014 (Stage III).

电气系统 / Electrical System

智能化计算机集成式可编程控制系统, 是该产品的关键核心技术, 采用PLC可编程控制器, 并与常规电气相结合, 完成系统的逻辑控制与液比例控制功能, 实现起重机的自动控制, 大大提高起重机的作业安全性、可靠性和作业效率。本机操作可通过电脑大屏幕显示出来, 很方便的实现人机对话。

Intelligent computer integrated programmable control system is the key technology of the crane. PLC programmable controller is used, in combination with conventional electrics, to realize logic control and electronic proportional control of the system, and to improve safety, reliability and efficiency for crane operation. Crane operation can be shown by a larger computer display, easy for man-machine interaction.

液压系统 / Hydraulic System

主系统(主副起升、变幅、行走)采用液压先导比例控制技术、开式回路、LUDV阀控流量调速系统、可实现完美的复合动作控制, 且能量损失小工作效率高, 起升、行走系统设置高低档位切换功能, 满足不同工况下的吊装要求。回转系统采用液压先导比例控制闭式控制系统。配置起重机专用闭式泵变量控制模块, 具有优越的启停缓冲功能, 启停平稳, 设置高低档位切换功能。上车辅助系统为电磁开关阀控液压系统, 电子遥控手柄操纵, 作业安全方便; 下车辅助动作采用手动六联多路阀控制系统, 操作方便易维护。设置独立液压驱动散热系统、散热功率大, 液压油箱有效容积大, 具有优良的的系统综合散热性能, 配置液压油温监测与自动调节功能。

Electronic proportional control, with combination of open/closed type circuit, main pump is variable displacement pump system, with distribution power control, no power over-ride, may realize flow distribution independent of load, and have the function of anti-current quantity saturation; engine power limit control may realize automatic power suit, efficiently avoid engine shut-down. Hydraulic system composition: hoist system, luffing system, slewing system, travel system, and auxiliary assembly system.

Features: Main pump has Δ P regulation function, may realize main system fine motion control; hoist system, main luffing system and travel system have high speed gear and fine motion gear for sensitive operation and smooth movement. Slewing gear is closed type system, quick response, accurate control, stable starting, braking and direction change, no impact, may satisfy operation of frequent direction change and fine motion control.

起升机构 / Hoist Gear

主副起升机构采用内藏式行星减速机, 独立驱动, 主起升机构采用销轴安装在转台上, 副起升机构通过销轴安装于主臂底节臂上, 以减轻主机运输重量。减速机安装有片式常闭制动器, 安全可靠。采用溅油方式润滑, 无需维护保养。起升机构还具有换油方便、低噪音、高效率、长寿命等特性。起升机构最大单绳速度可达120m/min, 同时具有优良的微动性能。

主、副起升机构使用独立钢芯、高破断拉力、高抗压性的抗旋转特种钢丝绳, 额定单绳拉力13.5t, 钢丝绳直径Φ26mm, 其中主卷长度315m, 副卷长度245m。

Main/auxiliary winch has built-in speed reducer with independent drive, and oil supplied by combination of two pumps, main hoist winch is installed with pin shaft on turntable and auxiliary hoist winch installed with pin shaft on boom base to reduce basic machine transport weight. Speed reducer has disc type constant closed brake with oil-bath lubrication for safe and reliable work without maintenance. Hoist winch also features easy oil change, low noise, high efficiency and long service life. Hoist winch max. single line speed is 120m/min, with good fine speed performance.

Main/auxiliary winch adopts separate steel core, high breaking force and high anti-extrusion of special anti-rotation wire rope, rated single line pull 13.5t, rope diameter Φ26mm, and main winch rope length 315m, auxiliary winch rope length 245m.

变幅机构 / Luffing Gear

主臂变幅机构为双联卷筒独立驱动, 采用内藏式行星减速机, 片式常闭制动器。卷筒设有棘轮锁止装置, 以实现机械制动, 安全可靠。主臂变幅机构与转台采用销轴连接, 便于组装。

主变幅机构采用独立钢芯、高破断拉力、结构稳定性极佳的特种钢丝绳, 额定单绳拉力2×10.2t, 钢丝绳直径Φ22mm, 长度270m。

Boom luffing gear is a twin drum independent drive unit, with built-in speed reducer and disc type constant closed brake. Winch drum has a ratchet locking device to realize mechanical braking, safe and reliable. Boom luffing gear is connected with turntable by pin shaft, easy for assembly.

Main luffing winch adopts separate steel core, high breaking force and high structural stability of special wire rope, rated single line pull 2×10.2t, rope diameter Φ22mm, rope length 270m.

回转机构 / Slewing Gear

回转机构布置在转台内侧前面, 由一个行星减速机组成, 与回转支承内啮合。液压缓冲, 具有自由滑转功能。可控常闭、片式制动器, 工作可靠, 防尘效果好。

Slewing gear is arranged inside the front of turntable, made up by one planetary reducers, and internal meshed with slewing ring, has the function of hydraulic buffering and free-swing. The controllable constant closed disc type brake is reliable for work and its dust prevention effect is good.

回转支承 / Slewing Ring

采用三排滚柱或双排球式回转支承, 质量稳定可靠。

Slewing ring is a 3-row roller or double volleyball type slewing bearing, with stable and reliable quality.

主机平衡重 / Counterweight

主机平衡重由车身配重和转台配重组成, 可进行自拆装(选配)。转台配重与转台的连接增加了销轴油缸, 消除了平衡重在拆装过程中的安全隐患, 车身配重安装在履带架前后。

转台配重共重58t, 包括:

平衡重托盘	18t/件	共1件,
平衡重I	5t/件	共8件,
车身配重	3t/件	共2件。

Counterweight consists of car-body counterweight and turntable counterweight, with self assembly/disassembly (optional). A pin shaft cylinder is added for connection between turntable and turntable counterweight, eliminated the hidden danger for safety of counterweight assembly/disassembly. Car-body is installed in the front/rear of track frame.

Turntable counterweight is 58t, includes:

Counterweight tray	18t/piece, total 1 piece;
Counterweight I	5t/piece, total 8 pieces;
Car-body Counterweight	3t/piece, total 2 pieces.

操纵室 / Operator's Cab

操纵室采用钢制框架结构, 配置有钢化玻璃。装有可调式座椅、按人机工程学布置的全套操纵仪表和控制装置, 配置风道式冷暖空调、音响、灭火装置、闭路监视系统等, 宽敞舒适。工作时, 操纵室可调整俯仰角度, 扩大视野, 方便操作; 运输时, 操纵室可从侧方转到前方, 减小运输宽度。

Operator's cabin is steel frame structure, the front windshield is provided with overall sandwich glass, other glass is all hardened glass, equipped with adjustable seat, ergonomic designed instruments and control devices, air-conditioner, CD player, fire extinguisher, closed circuit monitor and etc., spacious and comfortable. When working, the cabin's angle can be adjusted to enlarge the view field; when traveling, the cabin can be turned from the side to the front in order to reduce the transport width.

转台 / Turntable

转台采用高强度钢板焊接而成, 整体结构型式采用大箱形框架式等强度梁结构, 两侧工字形主立板用箱形梁左右联接。

该结构的优点为整体抗弯、抗扭能力强, 稳定性好, 转台内空间较大, 有利于保养及维护。

转台通过回转支承与下车联接。转台上安装有驾驶室、起升机构、变幅机构、发动机、桅杆、臂架及配重等重要部件。

Turntable is large box type structure welded by high-strength steel, with both side "工" type upright plate connected with box type beam at left and right.

The structure advantage is strong overall tensile strength, good stability and large inside space, helpful for maintenance.

It connects with the undercarriage through slewing ring, operator's cabin, winch system, luffing system, engine, mast, boom and counterweight etc. respectively arranged on the turntable at different positions.

下车 / Crane Carrier

下车包括车架、履带架、行走机构。车架和履带架采用销轴连接。

Crane carrier comprises car-body, track frame, and propel unit. Car-body and track frame take pin shaft connection.

车架 / Car-body

车架采用高强度钢板、箱形结构, 中间设置横隔板, 加强其抗扭刚度, 结构简单, 承载能力强, 刚性好。

Car-body is made of high-strength steel and welded in box type structure, with cross panel installed in the middle to strengthen its stiffness against torsion, simple structure, high loading capacity and well rigidity.

履带架 / Track Frame

包括履带梁和四轮一带。履带梁采用箱形结构, 和车架连接部位局部加强, 中间设置横隔板。两个履带架对称布置。四轮一带采用高强度合金铸钢铸造而成, 履带板宽度为1.0m。履带架上安装有销轴油缸, 用桅杆上的辅助安装油缸可方便实现履带架的自拆装。

Crawler travel unit consists of track frame, track shoe, drive sprocket, idler roller, track roller and travel motor. Track frame is box-type structure, connected with frame and strengthened partially, and cross panel is installed in the middle of it. Two track frames are symmetrically arranged. The four-roller and one-track are made of high-strength alloy casting steel. The track shoe width is 1.0m. On track frame installed pin shaft cylinder, with assistant cylinder on mast, easy for track frame self assembly and disassembly.

行走机构 / Crawler Travel Unit

行走机构采用内藏式行星齿轮减速机、轴向柱塞式变量马达驱动, 减速机带有液压释放行走制动器, 安全可靠。左右两套行走机构可同步操作, 也可单独操纵, 以实现直行和转弯。

Crawler travel unit uses built-in planetary gear reducer and axial piston variable displacement motor, the reducer has hydraulic release service brake, safe and reliable. Two crawler travel units at left and right can be operated not only synchronously but also independently to realize straight drive and turning around.

行走速度 / Travel Speed

变量马达可以实现无级变速, 最高速度1.3公里/小时。行走时, 设备运行平稳, 可实现快速行走。

Variable displacement motor can realize infinitely variable speeds, with max. speed 1.3 km/h, travel stable and fast.

详细介绍 Brief Introduction

作业设备 / Lifting Operation Parts

主臂 / Boom

主臂由底节臂、顶节臂和中间节组合而成，主臂为空间桁架式结构，底节臂、顶节臂为锥形变截面结构，顶节臂可联接固定副臂和臂端单滑轮机构，中间节为等截面结构。主臂用高强度优质钢管焊接而成，臂架顶部与根部用钢板加强，以利于传递载荷。主臂长度为16~76m。
组成：底节臂8m×1、中间节臂3m×2、中间节臂6m×1、中间节臂12m×4、顶节臂8m×1。

Boom comprises boom base, boom top and boom insert, with lattice type structure; boom base and boom top are tapered variable section, and boom top may be connected with fixed jib and single top, boom insert is variable section. Boom is welded by high-strength steel tube, boom top and boom foot are reinforced by steel plates for load transfer. Boom length is 16m~76m. Composition: boom base 8m×1, boom insert 3m×2, boom insert 6m×1, boom insert 12m×4, boom top 8m×1.

固定副臂 / Fixed Jib

主臂长37~64m范围内可安装固定副臂进行作业，固定副臂长度组合为13~31m，与主臂间的安装角分为15°和30°两种。
组成：底节臂6m、中间节臂6m×3、顶节臂7m。

Fixed jib can be attached and operated within the range of boom length 37m~64m, fixed jib length combination is 13m~31m, with two offset angle of 15° and 30°. Composition: jib base 6m, jib insert 6m×3, jib top 7m.

桅杆 / Mast

桅杆为箱形双肢结构，具有良好的整体稳定性。桅杆上安装有辅助拆装油缸，用于臂架及履带架自拆装，也可用于其它辅助吊装。

Mast is box-type structure of two limbs with good overall stability, and installed assistant cylinder for self assembly/disassembly of boom, track frame, and also for other auxiliary parts lifting.

吊钩 / Hook Block

标准配置：150t吊钩（选配）、100t吊钩、80t吊钩、32t吊钩、13.5t吊钩。

Standard equipment: 150t capacity hook block (optional), 100t capacity hook block, 80t capacity hook block, 32t capacity hook block, 13.5t capacity hook block.

安全装置 / Safety Devices

安全装置包括：

力矩限制器、主副提升防过卷装置、主副提升防过放装置、变幅棘爪装置、起重臂角度限位、主副臂防后倾系统、闭路监视系统（选配）、示高灯、风速仪、电子水平仪（选配）、防雷击系统（选配）、蜂鸣器及警示灯、功能互锁、应急功能、故障自诊断系统及黑匣子功能、断电保护等。

The safety protection devices comprise: load moment limiter, main/auxiliary winch over-wound protection, main/auxiliary winch over-release protection, winch ratchet locking device, boom angle limit, boom/jib backstop system, closed circuit monitor system(optional), height mark lamp, anemometer, level gauge (optional), lightning proof system(optional), buzzer and warning lamp, two-way hydraulic lock, emergency function, self diagnosis, black box and power cut-out protection.

力矩限制器系统 / Load Moment Limiter

检测功能：力矩限制器能自动检测出起重臂的角度、起重载荷大小。
显示功能：实时的显示当前实际载荷，工作半径，起重臂角度和当前风速。
警示功能：如果检测到实际载荷超过额定载荷，起重臂超过极限角度，力矩限制器发出报警并限制当前动作。

Detection function: automatically detect boom angle and lifting load.
Display function: real time display current actual load, working radius and boom angle.
Warning function: automatically send out warning signal and stop crane operation when detecting actual load exceeding rated load and boom out of limit angle.

主、副提升防过卷装置 / Main/Auxiliary Winch Over-wound Protection Device

当主、副卷扬起升到最大高度时，高度限位检测开关起作用，显示器中过卷保护指示灯亮，同时禁止卷扬起升动作。

When main/auxiliary winch hoists up to a certain lifting height, an over-wound warning lamp on instrument panel lights on, at the same time, load moment limiter stops crane hoisting up operation.

主、副提升防过放装置 / Main/Auxiliary Winch Over-release Protection Device

当主、副提升卷扬过放时，安装在卷筒内部的三圈保护开关检测到卷筒上的钢丝绳剩下三圈，显示器上的指示灯亮，同时禁止卷扬落动作。

A rope-end limiter is set on main and auxiliary hoist winch to protect wire rope from over-release, when only three turns of rope left on the drum, it stops drum hoisting down, and at the same a warning lamp on instrument panel lights up.

棘爪锁止装置 / Winch Ratchet Locking Device

该功能用于锁定变幅卷扬，起重臂降落的时候必须打开该装置，否则不能降落，用于保护臂架在非工作时安全停放。

Winch drum has a ratchet locking device, and it must be turned on when lowering boom, otherwise boom cannot be lowered. The device is used to stow the boom for safety.

起重臂角度限制 / Boom Angle Limit

起重臂角度限位是由力矩限制器和安装在臂架上的行程开关双重控制的，主臂达到80°时，控制系统将自动停止主臂的起臂动作，主臂仰角达到30°时，控制系统将自动停止主臂的落臂动作，同时蜂鸣器发出声音报警。

Boom angle limit is controlled by load moment limiter and hoist limit switch on boom. When boom angle is more than 80°, the boom control system stops boom raising. When boom angle is less than 30°, the boom control system stops boom lowering, and at the same time buzzers give a sound warning.

主副臂防后倾系统 / Boom / Jib Backstop System

主臂、副臂上安装有防后倾装置，当主副臂有后倾趋势时，防后倾装置可提供足够的防后倾力防止臂架后倾。

Boom and jib is installed a backstop device, when boom and jib have backwards tilting, the backstop device may provide enough support to prevent boom and jib from tilting backwards.

闭路监视系统（选配） / Closed Circuit Monitor System(Optional)

司机室安装有闭路监视系统，通过安装在桅杆上的摄像头和显示器，司机可即时观察起升机构、变幅机构的工作情况。

The operator's cabin has closed circuit monitor system, through the camera and monitor installed on turntable tail and boom, operator can keep watch on hoist winch and luffing gear working situation.

声光报警器 / Audio/Video Alarm

在履带起重机移动或做回转动作时，警示灯闪烁并且发出声音报警。

When crawler crane is moving and slewing, there is light and sound for warning.

三色力矩报警灯 / Tricolor Warning Lamp

由三种颜色组成，负载在90%以下时“绿灯”亮，表示起重机在安全区域运行，负载在90% - 100%的时候“黄灯”亮，表示起重机在已接近额定载荷范围，负载高于100%时“红灯”亮，表示起重机已经超载，在危险区域，控制系统自动切断起重机向危险的方向运行。

The lamp comprises 3 colors, when crane loading is below 90% of total rated lifting load, "Green Lamp" lights on to indicate crane is running in safety area; when crane loading is in 90%-100% of total rated lifting load, "Yellow Lamp" lights on to indicate crane is close to total rated lifting load; when crane loading is above 100% of total rated lifting load, Red Lamp" light on to indicate crane is overload; In dangerous area control system can automatically cut off crane movement to dangerous direction.

黑匣子 / Black Box

该功能可以将司机的操作及设备的运行参数记录下来，有利于分析事故原因。

The black box function is to record the operation data of operator and equipment, helpful for analysis of accident causes.

照明灯 / Illumination Lamp

装置在转台前方、桅杆上和操纵室内，用于为夜间工作提供照明。

There are illumination lamps at front of turntable, on mast and In operator's cabin for night operation.

示高灯 / Height Mark Lamp

安装在臂架顶部，作为高空警示。

Boom tip has a height mark lamp for high level operation warning.

风速仪 / Anemometer

实时检测当前风速，传送到操纵室的显示器上，提醒司机操作的安全性。

Anemometer at boom head can detect current wind speed and send wind signal to a monitor in operator's cabin to alert operator for safety.

水平仪 / Level Meter

配有电子（选配）和机械2种水平仪，可显示使用路面的倾斜程度，为操作者提供机器水平度参考。

The crane is equipped with 2 kinds of electronic and mechanical level meter, can indicate the road inclination degree, and provide operator with the machine level degree for reference.

防雷击保护装置（选配） / Lightning protection device (Optional)

加强设备雷雨天气下的防雷能力，有效保证设备的安全性。

The device can strengthen the equipment lightning protection ability under thunderstorm, effectively ensure the safety of the equipment.

远程GPS监控系统 / Remote GPS monitor

可实现GPS定位及GPRS数据传输，设备使用状态查询、远程故障诊断等功能。

The system can achieve GPS positioning and GPRS data transmission, the equipment uses status inquiries, remote fault diagnosis, and other functions.

工况示意图
Working Mode Illustration

09

XGC150-IA履带起重机
XGC150-I A CRAWLER CRANE

- P10-P10 工况示意图
Working Mode Illustration
- P11-P11 主臂工况臂节组合
Boom Combinations
- P12-P12 主臂作业范围图
Boom Working Area
- P13-P14 主臂作业范围图
Boom Working Area
- P15-P16 主臂起重性能表
Boom Lifting Load Chart
- P17-P18 臂端单滑轮起重性能表
Boom Single Pulley Lifting Load Chart

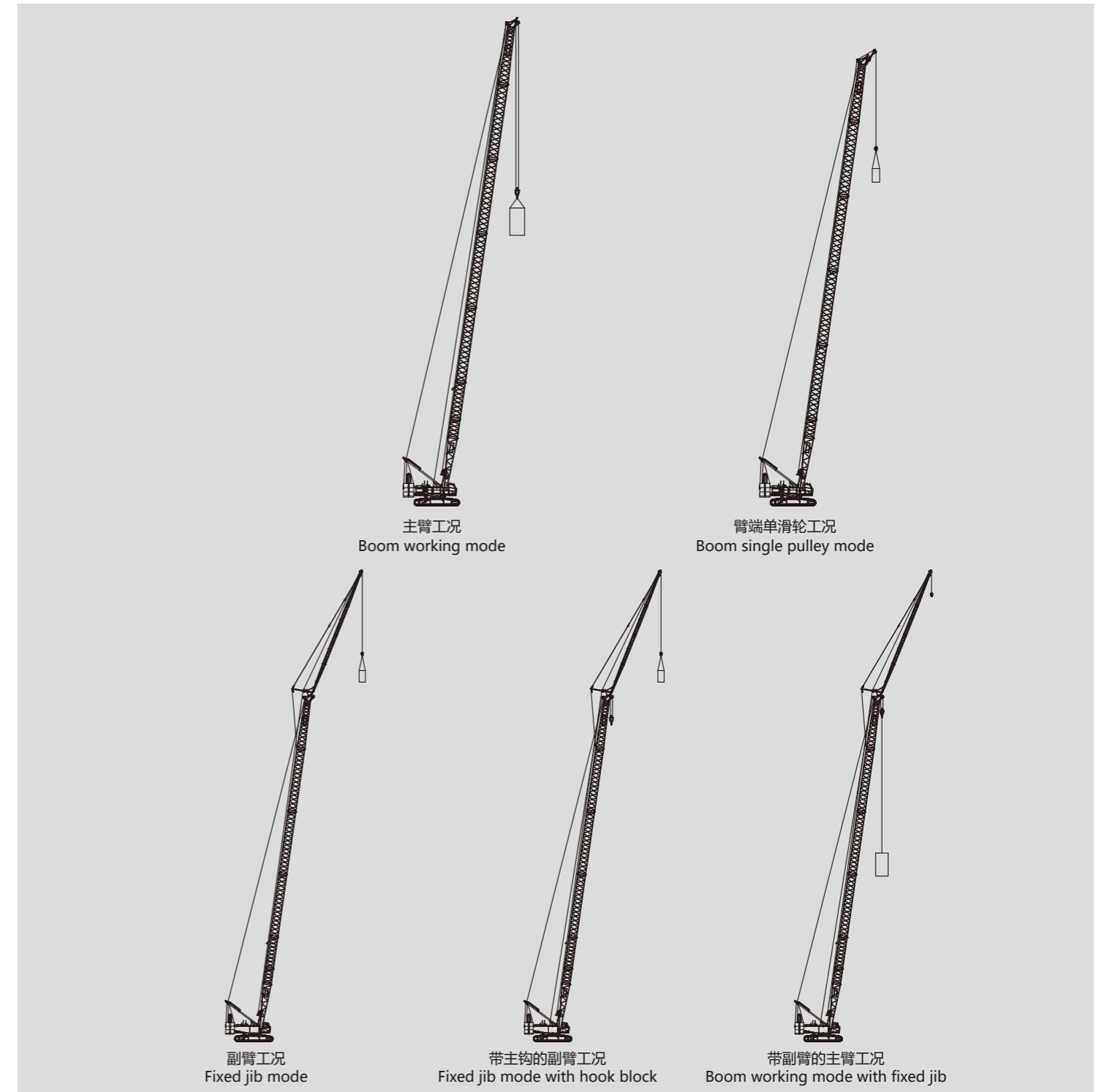

主臂工况臂节组合
Boom Combinations

臂长 Boom length	底节臂 Boom butt	中间节臂 Boom insert			顶节臂 Boom top
(m)	8m	3m	6m	12m	8m
16	1	0	0	0	1
19	1	1	0	0	1
22	1	0	1	0	1
25	1	1	1	0	1
28	1	0	0	1	1
31	1	1	0	1	1
34	1	0	1	1	1
37	1	1	1	1	1
40	1	0	0	2	1
43	1	1	0	2	1
46	1	0	1	2	1
49	1	1	1	2	1
52	1	0	0	3	1
55	1	1	0	3	1
58	1	0	1	3	1
61	1	1	1	3	1
64	1	0	0	4	1
67	1	1	0	4	1
70	1	0	1	4	1
73	1	1	1	4	1
76	1	2	1	4	1

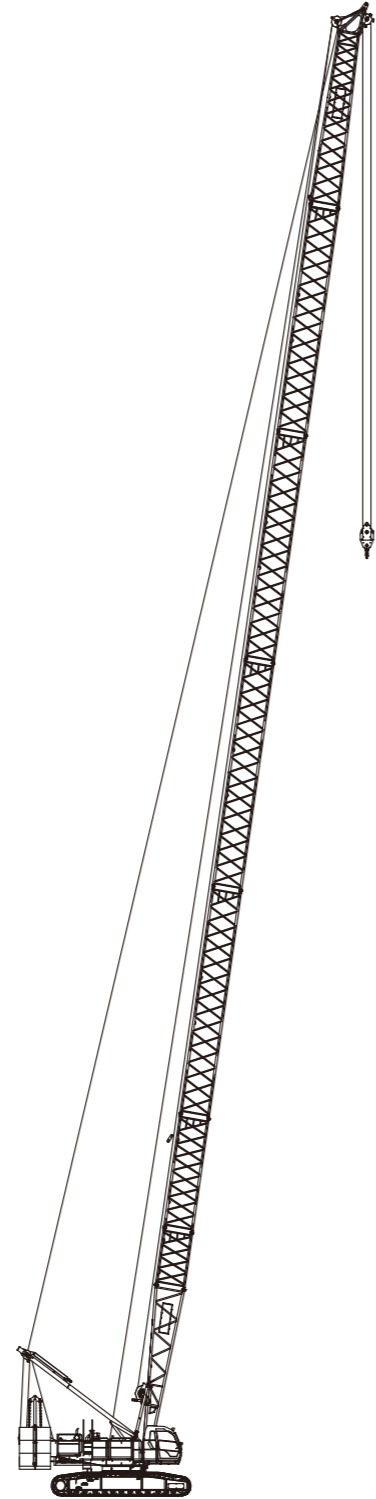

主臂作业范围图
Boom Working Area

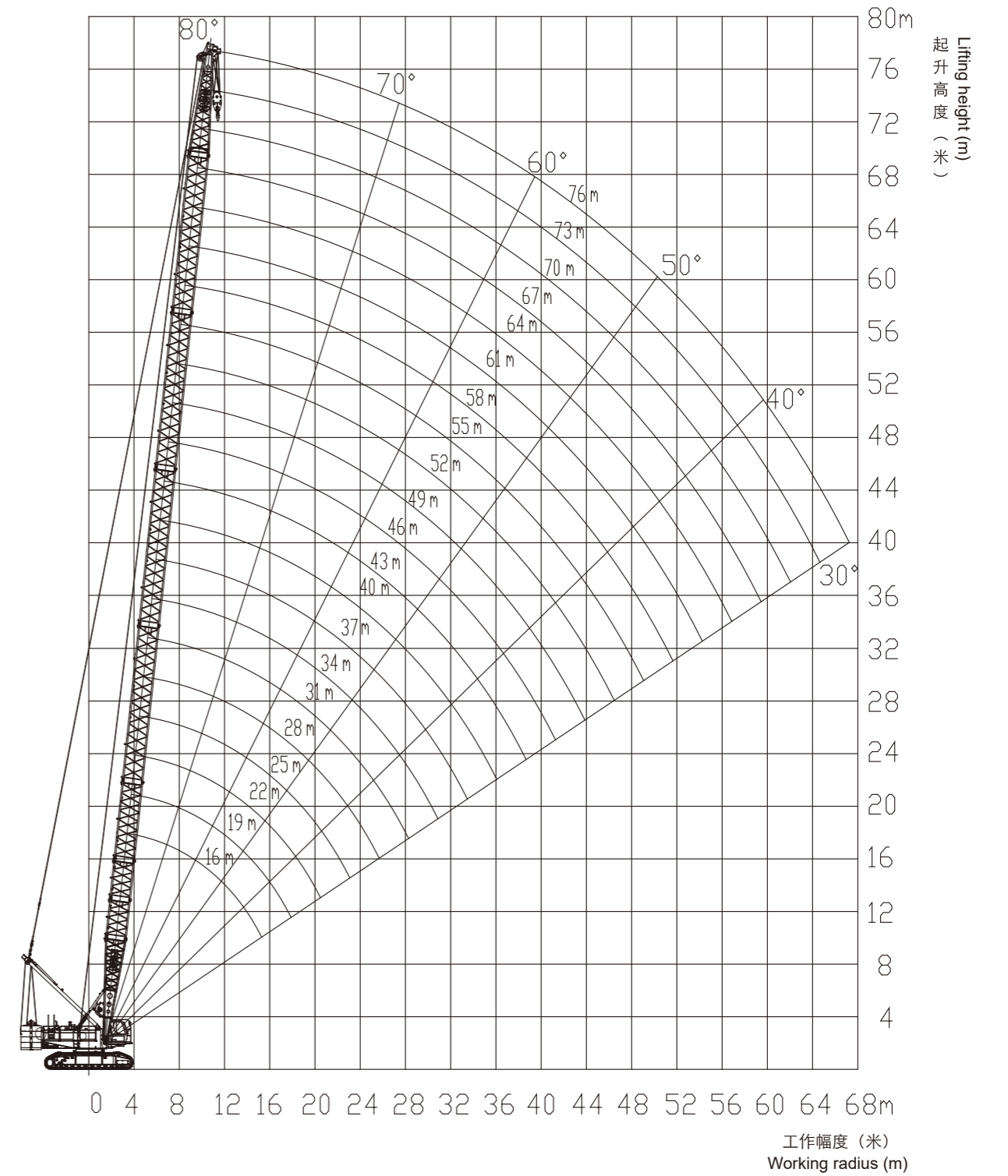

主臂起重性能表
Boom Lifting Load Chart

幅度 Radius	臂长 (米) Boom length(m)										
	16	19	22	25	28	31	34	37	40	43	46
5	150										
6	140	130	126								
7	113.9	111.6	109.3	107	104.8						
8	93.3	91.7	90.1	88.5	86.9	85.3	83.7				
9	78.5	77.7	76.5	75.3	74.1	72.8	71.6	70.4	69.2		
10	66.9	67.1	66.4	65.4	64.4	63.4	62.5	61.4	60.5	59.5	58.5
12	51.4	51.6	51.7	51.6	50.9	50.2	49.5	48.8	48.1	47.3	46.6
14	41.5	41.6	41.7	41.7	41.7	41.4	40.8	40.2	39.7	39.1	38.5
16		34.7	34.8	34.7	34.7	34.6	34.6	34.1	33.6	33.1	32.6
18		29.5	29.7	29.6	29.6	29.5	29.4	29.3	29.1	28.6	28.2
20			25.7	25.7	25.7	25.6	25.5	25.4	25.3	25.1	24.7
22				22.6	22.6	22.5	22.4	22.3	22.2	22	21.9
24					20.1	20	19.9	19.8	19.7	19.5	19.4
26						17.9	17.8	17.7	17.6	17.4	17.3
28						16.1	16	15.9	15.8	15.7	15.5
30							14.5	14.4	14.3	14.2	14
32								13.1	13	12.9	12.7
34									11.9	11.7	11.6
36									10.9	10.7	10.6
38										9.8	9.7
40											8.9
配重	48+6	48+6	48+6	48+6	48+6	48+6	48+6	48+6	48+6	48+6	48+6

幅度 Radius	臂长 (米) Boom length(m)										
	49	52	55	58	61	64	67	70	73	76	
12	45.9	46.2	45	40.1							
14	37.9	38.2	37.7	37.2	35.1	31.6	28.5				
16	32.1	32.4	32	31.6	31.1	30.7	27.8	25.1	22.8	20.2	
18	27.7	28	27.6	27.2	26.8	26.5	26.1	24.4	22.2	19.8	
20	24.3	24.5	24.1	23.8	23.5	23.1	22.8	22.4	21.5	19.5	
22	21.5	21.6	21.4	21	20.7	20.4	20.1	19.8	19.5	19	
24	19.2	19.1	18.9	18.8	18.5	18.2	17.9	17.6	17.3	17	
26	17.1	17	16.8	16.7	16.5	16.3	16	15.7	15.4	15.1	
28	15.4	15.2	15.1	14.9	14.7	14.6	14.4	14.1	13.9	13.6	
30	13.9	13.7	13.6	13.4	13.2	13.1	12.9	12.7	12.5	12.2	
32	12.6	12.4	12.3	12.1	11.9	11.8	11.6	11.4	11.2	11	
34	11.4	11.3	11.1	11	10.8	10.6	10.5	10.3	10.1	9.9	
36	10.4	10.3	10.1	10	9.8	9.6	9.5	9.3	9.1	8.9	
38	9.5	9.4	9.2	9.1	8.9	8.7	8.6	8.4	8.2	8	
40	8.7	8.6	8.4	8.3	8.1	8	7.8	7.6	7.4	7.2	
42	8	7.9	7.7	7.6	7.4	7.2	7.1	6.9	6.7	6.5	
44	7.4	7.2	7.1	6.9	6.7	6.6	6.4	6.2	6.1	5.9	
46		6.7	6.5	6.3	6.2	6	5.8	5.7	5.5	5.3	
48			6	5.8	5.6	5.5	5.3	5.1	4.9	4.8	
50				5.3	5.1	5	4.8	4.6	4.4	4.3	
52					4.7	4.5	4.4	4.2	4	3.8	
54					4.3	4.1	3.9	3.8	3.6	3.4	
56						3.7	3.5	3.4	3.2	3	
58							3.2	3	2.8	2.6	
60								2.7	2.5	2.3	
62								2.4	2.2	2	
64									1.9	1.7	
配重	48+6	48+6	48+6	48+6	48+6	48+6	48+6	48+6	48+6	48+6	48+6

主臂起重性能表
Boom Lifting Load Chart

幅度 Radius	主臂长度 Boom length(m)								
	22	25	28	31	34	37	40	43	43
8					95				
9				82.3	80.9	79.6	78.3		
10	75	73.9	72.8	71.7	70.6	69.5	68.5	67.4	67.4
12	58.4	58.4	57.7	56.9	56.1	55.3	54.5	53.7	53.7
14	47.2	47.2	47.2	46.9	46.3	45.7	45.1	44.5	44.5
16	39.5	39.4	39.4	39.3	39.2	38.8	38.3	37.8	37.8
18	33.7	33.7	33.7	33.6	33.5	33.4	33.2	32.7	32.7
20	29.3	29.3	29.3	29.2	29.1	29	28.9	28.7	28.7
22		25.8	25.8	25.7	25.6	25.5	25.4	25.3	25.3
24			23	22.9	22.8	22.7	22.6	22.4	22.4
26				20.5	20.5	20.3	20.2	20.1	20.1
28				18.6	18.5	18.3	18.3	18.1	18.1
30					16.8	16.7	16.6	16.4	16.4
32						15.2	15.1	15	15
34							13.8	13.7	13.7
36							12.7	12.6	12.6
38								11.6	11.6
40									
配重	58+6	58+6	58+6	58+6	58+6	58+6	58+6	58+6	58+6

幅度 Radius	主臂长度 Boom length(m)									
	49	52	55	58	61	64	67	70	73	76
12	52.2	50.6	45	40.1						
14	43.2	43.5	43	39.2	35.1	31.6	28.5			
16	36.7	37	36.5	36.1	34.2	30.8	27.8	25.1	22.8	20.2
18	31.8	32	31.6	31.2	30.8	30	27	24.4	22.2	19.8
20	27.9	28.1	27.7	27.4	27	26.6	26.3	23.8	21.5	19.5
22	24.8	24.8	24.6	24.3	23.9	23.6	23.3	22.9	20.9	19
24	22.1	22	21.8	21.7	21.4	21.1	20.8	20.5	20.1	18.4
26	19.8	19.7	19.5	19.3	19.2	19	18.7	18.4	18.1	17.8
28	17.8	17.7	17.5	17.4	17.2	17	16.9	16.6	16.3	16
30	16.1	16	15.8	15.7	15.5	15.3	15.2	15	14.8	14.5
32	14.7	14.5	14.4	14.2	14	13.9	13.7	13.5	13.4	13.2
34	13.4	13.3	13.1	12.9	12.8	12.6	12.4	12.3	12.1	11.9
36	12.3	12.1	12	11.8	11.6	11.5	11.3	11.1	11	10.8
38	11.3	11.2	11	10.8	10.6	10.5	10.3	10.1	10	9.8
40	10.4	10.3	10.1	9.9	9.8	9.6	9.4	9.3	9.1	8.9
42	9.6	9.5	9.3	9.1	9	8.8	8.6	8.5	8.3	8.1
44	8.9	8.7	8.6	8.4	8.2	8.1	7.9	7.7	7.6	7.4
46		8.1	7.9	7.8	7.6	7.4	7.3	7.1	6.9	6.7
48			7.3	7.2	7	6.8	6.7	6.5	6.3	6.1
50				6.6	6.4	6.3	6.1	5.9	5.7	5.6
52					5.9	5.8	5.6	5.4	5.2	5.1
54					5.5	5.3	5.1	5	4.8	4.6
56						4.9	4.7	4.5	4.3	4.2
58							4.3	4.1	3.9	3.8
60								3.8	3.6	3.4
62								3.4	3.2	3
64									2.9	2.7
66										2.4
配重=	58+6	58+6	58+6	58+6	58+6	58+6	58+6	58+6	58+6	58+6

臂端单滑轮起重性能表
Boom Single Pulley
Lifting Load Chart

幅度 Radius	主臂长度 Boom length(m)									
	22	25	28	31	34	37	40	43	46	49
10						13.5	13.5			
12		13.5	13.5	13.5	13.5	13.5	13.5	13.5	13.5	13.5
14	13.5	13.5	13.5	13.5	13.5	13.5	13.5	13.5	13.5	13.5
16	13.5	13.5	13.5	13.5	13.5	13.5	13.5	13.5	13.5	13.5
18	13.5	13.5	13.5	13.5	13.5	13.5	13.5	13.5	13.5	13.5
20	13.5	13.5	13.5	13.5	13.5	13.5	13.5	13.5	13.5	13.5
22		13.5	13.5	13.5	13.5	13.5	13.5	13.5	13.5	13.5
24		13.5	13.5	13.5	13.5	13.5	13.5	13.5	13.5	13.5
26			13.5	13.5	13.5	13.5	13.5	13.5	13.5	13.5
28				13.5	13.5	13.5	13.5	13.5	13.5	13.5
30					13.5	13.5	13.5	13.5	13.5	13.5
32					13.5	13.5	13.5	13.5	13.5	13.5
34						13.5	13.5	13.5	13.5	13.4
36							12.7	12.6	12.5	12.3
38								11.6	11.5	11.3
40								10.7	10.6	10.4
42									9.8	9.6
44										8.9
配重	58+6	58+6	58+6	58+6	58+6	58+6	58+6	58+6	58+6	58+6

幅度 Radius	主臂长度 Boom length(m)									
	52	55	58	61	64	67	70	73	76	
12	13.5									
14	13.5	13.5	13.5	13.5	13.5					
16	13.5	13.5	13.5	13.5	13.5	13.5	13.5	13.5	13.5	13.5
18	13.5	13.5	13.5	13.5	13.5	13.5	13.5	13.5	13.5	13.5
20	13.5	13.5	13.5	13.5	13.5	13.5	13.5	13.5	13.5	13.5
22	13.5	13.5	13.5	13.5	13.5	13.5	13.5	13.5	13.5	13.5
24	13.5	13.5	13.5	13.5	13.5	13.5	13.5	13.5	13.5	13.5
26	13.5	13.5	13.5	13.5	13.5	13.5	13.5	13.5	13.5	13.5
28	13.5	13.5	13.5	13.5	13.5	13.5	13.5	13.5	13.5	13.5
30	13.5	13.5	13.5	13.5	13.5	13.5	13.5	13.5	13.5	13.5
32	13.5	13.5	13.5	13.5	13.5	13.5	13.5	13.5	13.4	13.2
34	13.3	13.1	13	12.8	12.7	12.5	12.3	12.1	12	12
36	12.2	12	11.9	11.7	11.5	11.4	11.2	11	10.8	10.8
38	11.2	11	10.9	10.7	10.5	10.4	10.2	10	9.8	9.8
40	10.3	10.1	10	9.8	9.6	9.5	9.3	9.1	8.9	8.9
42	9.5	9.3	9.2	9	8.8	8.7	8.5	8.3	8.1	8.1
44	8.8	8.6	8.4	8.3	8.1	7.9	7.8	7.6	7.4	7.4
46	8.1	7.9	7.8	7.6	7.5	7.3	7.1	6.9	6.7	6.7
48		7.3	7.2	7	6.8	6.7	6.5	6.3	6.1	6.1
50		6.8	6.6	6.4	6.3	6.1	5.9	5.8	5.6	5.6
52			6.1	5.9	5.8	5.6	5.4	5.3	5.1	5.1
54				5.5	5.3	5.1	5	4.8	4.6	4.6
56					4.9	4.7	4.5	4.3	4.2	4.2
58					4.5	4.3	4.1	3.9	3.8	3.8
60						3.9	3.7	3.6	3.4	3.4
62							3.4	3.2	3	3
64								2.9	2.7	2.7
66								2.6	2.4	2.4
68									2.1	2.1
配重	58+6	58+6	58+6	58+6	58+6	58+6	58+6	58+6	58+6	58+6

17

XGC150-IA履带起重机 XGC150-I A CRAWLER CRANE

- P18-P18 固定副臂臂节组合
Fixed Jib Combinations
- P19-P19 固定副臂作业范围图
Fixed Jib Working Area
- P20-P25 固定副臂起重性能表
Fixed Jib Lifting Load Chart
- P26-P29 主要零部件
Main parts
- P30-P30 工作条件及注意
Working conditions and Cautions

固定副臂臂节组合 Fixed Jib Combinations

副臂长度 Jib length (m)	13	19	25	31
6m底节臂Jib base	1	1	1	1
6m中间节Jib insert		1	2	3
7m顶节臂Jib top	1	1	1	1

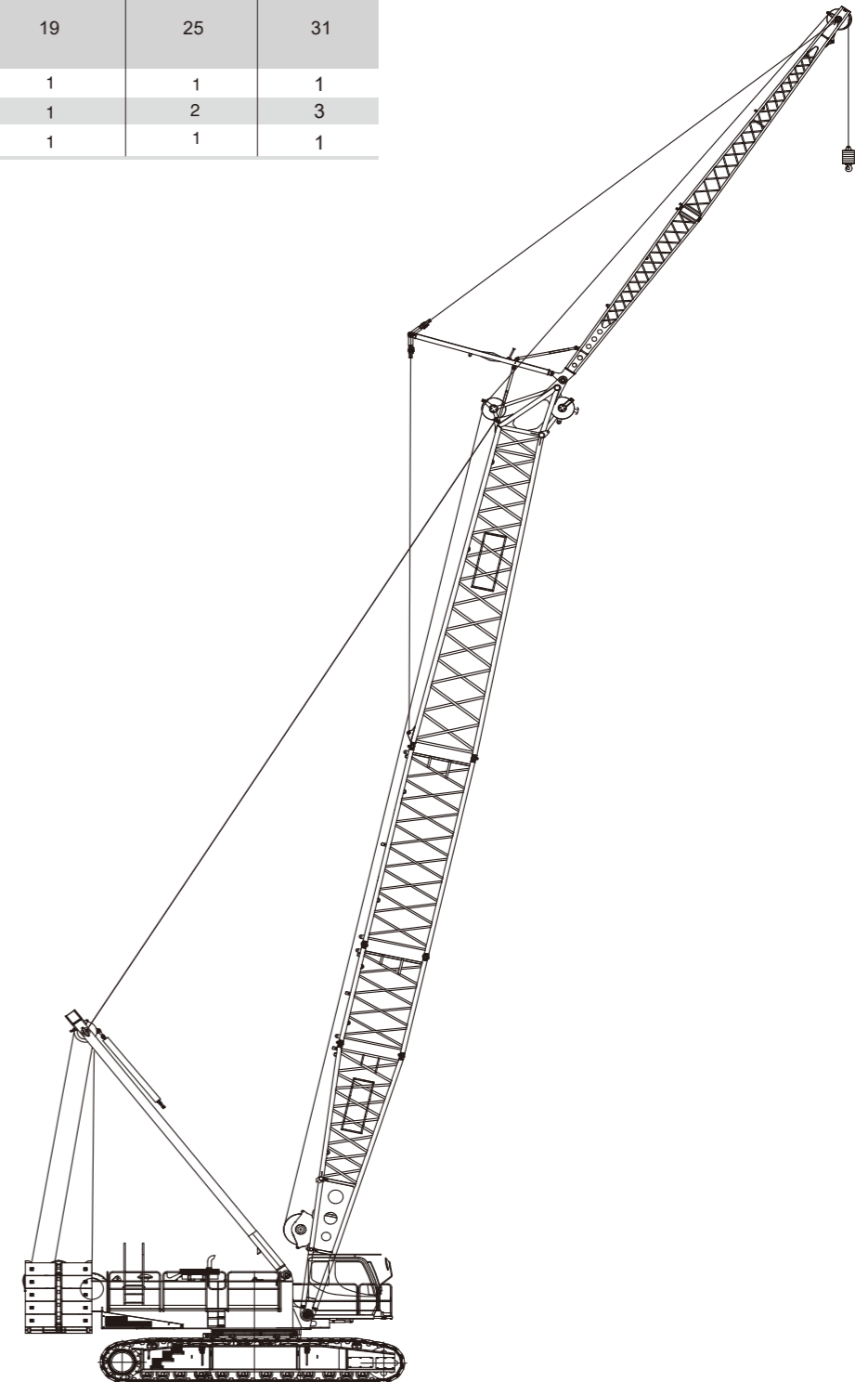

固定副臂作业范围图
Fixed Jib Working Area

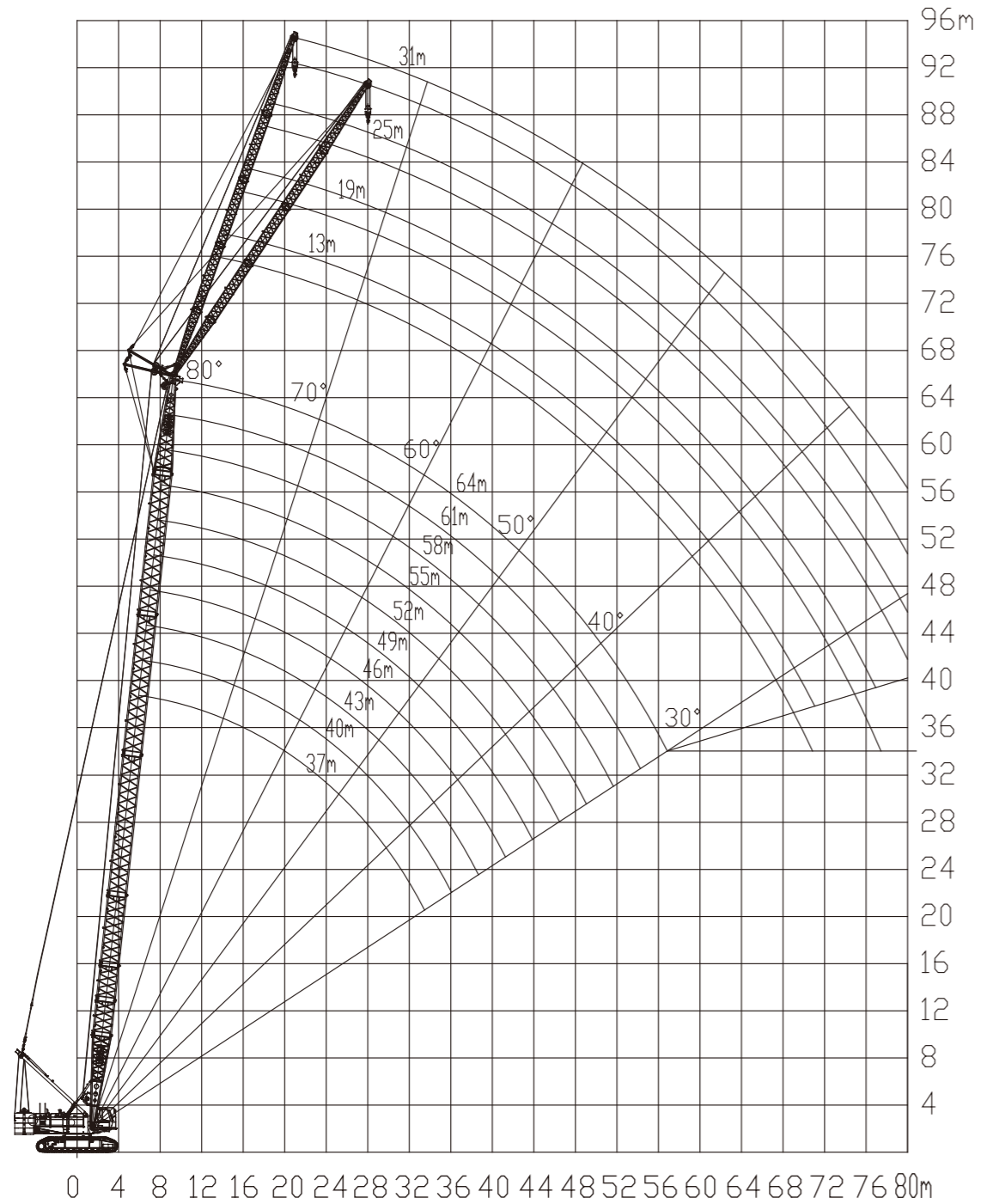

工作幅度 (米)
Working radius (m)

固定副臂起重性能表
Fixed Jib Lifting Load Chart

副臂夹角 Jib angle(°)	15											
主臂长 Boom length(m)	37				40				43			
副臂长 Jib length(m)	13	19	25	31	13	19	25	31	13	19	25	31
工作幅度 Working radius(m)												
14	22				22							
16	22				22				22			
18	21.6	15.3			21.5	15.4			22	15.4		
20	20.9	14.8	11.4		21.3	14.9	11.4		21.4	14.9		
22	20	14.3	11		20.6	14.4	11		20.8	14.5	11.1	
24	18.8	13.9	10.6	7.9	19.4	14	10.7	7.9	20	14.1	10.7	7.9
26	17.8	13.5	10.3	7.6	18.4	13.6	10.4	7.7	19	13.7	10.4	7.7
28	16.9	13.1	10	7.3	17.5	13.2	10.1	7.4	18.1	13.3	10.1	7.5
30	16.1	12.7	9.7	7	16.7	12.9	9.8	7.1	16.5	13	9.9	7.2
32	15.3	12.1	9.4	6.7	15.2	12.5	9.5	6.9	15	12.7	9.6	7
34	14	11.5	9.1	6.5	13.9	11.9	9.2	6.6	13.7	12.3	9.3	6.7
36	12.9	11	8.7	6.3	12.7	11.4	9	6.4	12.6	11.7	9.1	6.5
38	11.8	10.5	8.3	6.1	11.7	10.9	8.6	6.2	11.5	11.3	8.8	6.3
40	10.9	10.1	8	5.9	10.8	10.5	8.2	6	10.6	10.8	8.5	6.1
42	10.1	9.7	7.6	5.7	10	10.1	7.9	5.9	9.8	10.1	8.1	6
44	9.3	9.4	7.3	5.6	9.2	9.5	7.6	5.7	9.1	9.4	7.8	5.8
46	8.6	9	7	5.4	8.5	8.9	7.3	5.6	8.4	8.7	7.5	5.7
48		8.4	6.8	5.3	7.9	8.2	7	5.4	7.8	8.1	7.2	5.5
50		7.8	6.5	5.2		7.7	6.8	5.3	7.2	7.5	7	5.4
52		7.2	6.3	5.1		7.1	6.5	5.2		7	6.7	5.3
54			6.1	4.9		6.6	6.3	5.1		6.5	6.5	5.2
56			5.9	4.7			6.1	4.9		6	6.2	5.1
58				4.6			5.9	4.7			5.8	4.9
60				4.4			5.6	4.6			5.4	4.7
62				4.3				4.4			5	4.6
64								4.3				4.4
66								4.2				4.3
68												4.2
配重	58+6	58+6	58+6	58+6	58+6	58+6	58+6	58+6	58+6	58+6	58+6	58+6

固定副臂起重性能表
Fixed Jib Lifting Load Chart

副臂夹角 Jib angle(°)	15											
主臂长 Boom length(m)	46				49				52			
副臂长 Jib length(m)	13	19	25	31	13	19	25	31	13	19	25	31
工作幅度 Working radius(m)												
16	22				22							
18	22				22				21.9			
20	21.5	14.9			21.5	14.9			21.4	14.9		
22	20.9	14.5	11.1		21	14.6	11		20.9	14.5		
24	20.4	14.1	10.8	7.9	20.5	14.2	10.8		20.5	14.2	10.7	
26	19.5	13.8	10.5	7.7	20	13.8	10.5	7.7	19.8	13.8	10.5	7.6
28	18.1	13.4	10.2	7.5	17.9	13.5	10.2	7.5	17.8	13.5	10.2	7.5
30	16.4	13.1	9.9	7.3	16.2	13.2	10	7.3	16	13.2	10	7.3
32	14.9	12.8	9.7	7.1	14.7	12.9	9.7	7.1	14.5	13	9.8	7.1
34	13.5	12.5	9.4	6.8	13.4	12.6	9.5	6.9	13.2	12.7	9.5	7
36	12.4	12.1	9.2	6.6	12.2	12.4	9.3	6.7	12.1	12.4	9.3	6.8
38	11.4	11.6	9	6.4	11.2	11.6	9.1	6.5	11.1	11.4	9.1	6.6
40	10.5	10.8	8.7	6.3	10.3	10.6	8.9	6.4	10.1	10.5	8.9	6.5
42	9.6	10	8.3	6.1	9.5	9.8	8.6	6.2	9.3	9.7	8.8	6.3
44	8.9	9.2	8	5.9	8.7	9.1	8.2	6	8.6	8.9	8.5	6.1
46	8.2	8.5	7.7	5.8	8	8.4	7.9	5.8	7.9	8.2	8.1	6
48	7.6	7.9	7.4	5.6	7.4	7.7	7.6	5.7	7.3	7.6	7.8	5.8
50	7	7.3	7.2	5.5	6.9	7.2	7.4	5.6	6.7	7	7.2	5.7
52	6.5	6.8	6.9	5.4	6.3	6.6	6.9	5.5	6.2	6.5	6.7	5.6
54	6	6.3	6.5	5.3	5.8	6.1	6.4	5.4	5.7	6	6.2	5.5
56		5.9	6.1	5.2	5.4	5.7	5.9	5.3	5.3	5.5	5.8	5.3
58		5.4	5.7	5.1		5.3	5.5	5.2	4.8	5.1	5.3	5.2
60			5.3	4.9		4.9	5.1	5		4.7	4.9	5.1
62			4.9	4.7		4.5	4.7	4.9		4.3	4.6	4.7
64			4.5	4.6			4.4	4.5		4	4.2	4.4
66				4.3			4	4.2			3.9	4
68				4			3.7	3.9			3.6	3.7
70				3.7				3.6			3.3	3.4
72								3.3				3.2
74												2.9
76												2.6
配重	58+6	58+6	58+6	58+6	58+6	58+6	58+6	58+6	58+6	58+6	58+6	58+6

副臂夹角 Jib angle(°)	15															
主臂长 Boom length(m)	55				58				61				64			
副臂长 Jib length(m)	13	19	25	31	13	19	25	31	13	19	25	31	13	19	25	31
工作幅度 Working radius(m)																
18	21.8				21.5								19.2			
20	21.3	14.8			21.2								19.1			16.8
22	20.9	14.5			20.8	14.4							19	14.2		16.7
24	20.4	14.2	10.6		20.4	14.1	10.5						18.9	14	10.3	16.6
26	19.5	13.8	10.4	7.6	19.2	13.8	10.3	7.5					18.8	13.7	10.2	16.5
28	17.6	13.5	10.2	7.4	17.4	13.5	10.2	7.4					17.1	13.5	10	16.3
30	15.9	13.3	10	7.3	15.7	13.3	10	7.2					15.5	13.2	9.9	15.3
32	14.4	13	9.8	7.1	14.2	13	9.8	7.1					14	13	9.7	13.9
34	13.1	12.7	9.6	7	12.9	12.8	9.6	7					12.7	12.7	9.6	12.6
36	11.9	12.3	9.4	6.8	11.7	12.1	9.4	6.8					11.6	12	9.4	11.4
38	10.9	11.3	9.2	6.7	10.7	11.1	9.2	6.7					10.5	10.9	9.2	10.4
40	10	10.3	9	6.5	9.8	10.2	9	6.6					9.6	10	9.1	9.5
42	9.1	9.5	8.8	6.4	9	9.3	8.9	6.4					8.8	9.2	8.9	8.6
44	8.4	8.7	8.7	6.2	8.2	8.6	8.7	6.3					8.1	8.4	8.7	7.9
46	7.7	8.1	8.3	6.1	7.6	7.9	8.1	6.2					7.4	7.7	8	7.2
48	7.1	7.4	7.7	5.9	6.9	7.3	7.5	6					6.8	7.1	7.3	6.6
50	6.5	6.8	7.1	5.8	6.4	6.7	6.9	5.9					6.2	6.5	6.7	6
52	6	6.3	6.5	5.7	5.8	6.2	6.4	5.8					5.7	6	6.2	5.5
54	5.5	5.8	6.1	5.5	5.4	5.7	5.9	5.6					5.2	5.5	5.7	5
56	5.1	5.4	5.6	5.4	4.9	5.2	5.4	5.5					4.7	5	5.3	4.6
58	4.7	4.9	5.2	5.3	4.5	4.8	5	5.2					4.3	4.6	4.8	4.2
60	4.3	4.6	4.8	4.9	4.1	4.4	4.6	4.8					3.9	4.2	4.4	3.8
62		4.2	4.4	4.5	3.7	4	4.2	4.4					3.6	3.8	4.1	3.4
64		3.8	4	4.2	3.4	3.7	3.9	4					3.2	3.5	3.7	3.1
66		3.5	3.7	3.9		3.3	3.6	3.7					2.9	3.2	3.4	2.7
68			3.4	3.6		3	3.2	3.4					2.9	3.1	3.2	2.4
70			3.1	3.3		2.7	2.9	3.1					2.6	2.8	2.9	2.4
72			2.8	3			2.7	2.8					2.3	2.5	2.6	2.1
74				2.7			2.4	2.6					2.2	2.4		1.9
76				2.5			2.1	2.3					2	2.1		1.8
78				2.2				2.1					1.7	1.9		1.6
80								1.8					1.7			
配重	58+6	58+6	58+6	58+6	58+6	58+6	58+6	58+6	58+6	58+6	58+6	58+6	58+6	58+6	58+6	58+6

固定副臂起重性能表
Fixed Jib Lifting Load Chart

副臂夹角 Jib angle(°)	30											
主臂长 Boom length(m)	37				40				43			
副臂长 Jib length(m)	13	19	25	31	13	19	25	31	13	19	25	31
工作幅度 Working radius(m)												
18	17				17				17			
20	16.3				16.3				16.3			
22	15.6	10.4			15.6	10.5			15.6			
24	14.8	10.2			14.8	10.3			14.8	10.4		
26	13.7	10.1	7.8		13.7	10.1	7.9		13.7	10.2		
28	12.9	10	7.4		12.9	10	7.5		12.9	10.1	7.6	
30	12.1	9.7	7	5.6	12.1	9.7	7.1	5.6	12.1	9.8	7.2	5.7
32	11.3	9.3	6.7	5.5	11.3	9.3	6.8	5.5	11.4	9.4	6.9	5.6
34	10.7	8.9	6.5	5.3	10.8	8.9	6.6	5.3	10.9	9	6.7	5.4
36	10.1	8.5	6.3	5.1	10.1	8.5	6.4	5.2	10.2	8.5	6.5	5.2
38	9.6	8	6.1	5	9.7	8	6.2	5.1	9.8	8	6.3	5.1
40	9.4	7.5	5.9	4.8	9.5	7.5	6	4.9	9.6	7.6	6.1	4.9
42	9.3	7.3	5.7	4.6	9.4	7.3	5.8	4.7	9.5	7.4	5.9	4.8
44	9.1	6.9	5.5	4.4	9.2	6.9	5.6	4.5	9.2	7	5.7	4.6
46		6.7	5.4	4.3	8.6	6.8	5.5	4.3	8.5	6.9	5.6	4.4
48		6.6	5.2	4.1		6.7	5.3	4.2	7.8	6.8	5.4	4.3
50		6.5	5.1	4		6.6	5.2	4.1		6.7	5.3	4.1
52			5	3.9		6.5	5.1	3.9		6.6	5.2	4
54			4.9	3.7			4.9	3.8		6.5	5	3.9
56			4.8	3.6			4.8	3.7			4.9	3.8
58				3.5			4.8	3.6			4.8	3.7
60				3.5				3.5			4.8	3.6
62				3.4				3.4				3.5
64								3.4				3.4
66												3.4
配重	58+6	58+6	58+6	58+6	58+6	58+6	58+6	58+6	58+6	58+6	58+6	58+6

副臂夹角 Jib angle(°)	30											
主臂长 Boom length(m)	46				49				52			
副臂长 Jib length(m)	13	19	25	31	13	19	25	31	13	19	25	31
工作幅度 Working radius(m)												
20	16.3				16.3				16.4			
22	15.6				15.6				15.6			
24	14.8	10.4			14.8	10.5			14.8	10.6		
26	13.7	10.2			13.7	10.3			13.7	10.4		
28	12.9	10.1	7.7		12.9	10.2	7.8		12.9	10.2	7.9	
30	12.1	9.9	7.3		12.2	10	7.4		12.3	10.1	7.5	
32	11.5	9.4	7	5.6	11.6	9.5	7.1	5.6	11.7	9.5	7.2	5.6
34	11	9.1	6.8	5.4	11.1	9.2	6.9	5.4	11.2	9.2	7	5.4
36	10.3	8.5	6.6	5.3	10.4	8.5	6.7	5.3	10.5	8.6	6.8	5.3
38	9.9	8	6.4	5.1	10	8.1	6.5	5.2	10.1	8.2	6.6	5.2
40	9.7	7.7	6.2	5	9.8	7.7	6.3	5.1	9.9	7.8	6.4	5.1
42	9.6	7.5	6	4.8	9.6	7.5	6.1	4.9	9.5	7.6	6.2	5
44	9	7.1	5.8	4.7	8.9	7.2	5.9	4.7	8.8	7.4	6	4.8
46	8.3	7	5.7	4.5	8.2	7.1	5.8	4.6	8.1	7.3	5.9	4.6
48	7.7	6.9	5.5	4.4	7.5	7	5.6	4.4	7.4	7.1	5.7	4.5
50	7.1	6.8	5.4	4.2	6.9	6.9	5.5	4.3	6.8	7	5.5	4.4
52	6.5	6.7	5.2	4.1	6.4	6.8	5.3	4.2	6.3	6.7	5.4	4.2
54		6.4	5.1	4	5.9	6.3	5.2	4	5.8	6.2	5.3	4.1
56		5.9	5	3.8		5.8	5.1	3.9	5.3	5.7	5.2	4
58		5.5	4.9	3.7		5.3	5	3.8		5.2	5	3.9
60			4.8	3.6		4.9	4.9	3.7		4.8	4.9	3.8
62			4.7	3.6			4.8	3.6		4.4	4.7	3.7
64			4.6	3.5			4.5	3.5			4.4	3.6
66				3.4			4.1	3.5			4	3.5
68				3.3				3.4			3.7	3.4
70				3.3				3.3				3.4
72								3.3				3.3
74												3
配重	58+6	58+6	58+6	58+6	58+6	58+6	58+6	58+6	58+6	58+6	58+6	58+6

固定副臂起重性能表
Fixed Jib Lifting Load Chart

副臂夹角 Jib angle(°)	30															
主臂长 Boom length(m)	55				58				61				64			
副臂长 Jib length(m)	13	19	25	31	13	19	25	31	13	19	25	31	13	19	25	31
工作幅度 Working radius(m)																
20	16.3															
22	15.5				15.4					15.4					15.4	
24	14.8				14.8					14.8					14.8	
26	13.6	10.4			13.5	10.4				13.5	10.4			13.5	10.4	
28	12.8	10.2			12.7	10.2				12.7	10.2			12.7	10.2	
30	12.2	10.1	7.6		12.1	10.1	7.7			12.2	10.1	7.8		12.3	10.1	7.9
32	11.7	9.5	7.3		11.7	9.6	7.4			11.8	9.6	7.4		11.9	9.6	7.5
34	11.2	9.1	7.1	5.5	11.3	9.1	7.2	5.4		11.4	9	7.2	5.5	11.5	9	7.3
36	10.5	8.5	6.9	5.3	10.6	8.5	7	5.3		10.7	8.5	7	5.4	10.8	8.6	7.1
38	10.1	8.1	6.7	5.2	10.2	8.2	6.8	5.2		10.3	8.3	6.8	5.3	10.5	8.4	6.9
40	9.9	7.9	6.5	5.1	10	8	6.6	5.1		9.9	8.1	6.6	5.2	9.8	8.2	6.7
42	9.4	7.7	6.3	5	9.2	7.8	6.4	5		9.1	7.9	6.5	5.1	8.9	8	6.5
44	8.6	7.5	6.1	4.8	8.4	7.6	6.2	4.9		8.3	7.7	6.3	5	8.1	7.8	6.3
46	7.9	7.4	5.9	4.7	7.7	7.5	6	4.8		7.6	7.6	6.1	4.8	7.4	7.7	6.2
48	7.3	7.2	5.8	4.5	7.1	7.3	5.9	4.6		6.9	7.4	5.9	4.7	6.8	7.3	6
50	6.7	7.1	5.6	4.4	6.5	7	5.7	4.5		6.4	6.8	5.8	4.5	6.2	6.7	5.9
52	6.1	6.5	5.5	4.3	6	6.4	5.6	4.3		5.8	6.2	5.6	4.4	5.7	6.1	5.7
54	5.6	6	5.4	4.1	5.5	5.9	5.4	4.2		5.3	5.7	5.5	4.3	5.2	5.6	5.6
56	5.1	5.5	5.2	4	5	5.4	5.3	4.1		4.8	5.2	5.4	4.1	4.7	5.1	5.4
58	4.7	5.1	5.1	3.9	4.6	4.9	5.2	4		4.4	4.8	5.1	4	4.3	4.7	5
60		4.7	5	3.8	4.1	4.5	4.9	3.9		4	4.4	4.7	3.9	3.9	4.2	4.6
62		4.3	4.6	3.7	3.8	4.1	4.5	3.8		3.6	4	4.3	3.8	3.5	3.8	4.2
64		3.9	4.2	3.6		3.8	4.1	3.7		3.2	3.6	3.9	3.7	3.1	3.5	3.8
66			3.9	3.5		3.4	3.7	3.6			3.3	3.6	3.7	2.8	3.1	3.4
68			3.5	3.5		3.1	3.4	3.5			2.9	3.2	3.5		2.8	3.1
70			3.2	3.4			3.1	3.3			2.6	2.9	3.2		2.5	2.8
72				3.2			2.8	3			2.6	2.9		2.2	2.5	2.8
74				2.9			2.5	2.7			2.3	2.6			2.2	2.5
76				2.6				2.5			2	2.3			1.9	2.2
78								2.2				2			1.7	1.9
80												1.8				1.7
配重	58+6	58+6	58+6	58+6	58+6	58+6	58+6	58+6	58+6	58+6	58+6	58+6	58+6	58+6	58+6	58+6

主要零部件
Main parts

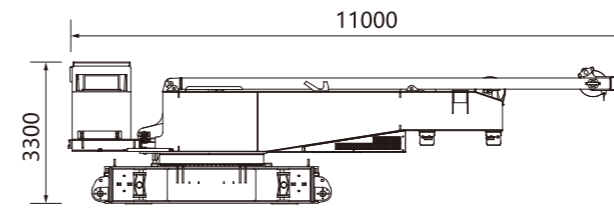

主机运输方案 A Basic machine transport plan A	×1
长(L)	11000mm
宽(W)	3000mm
高(H)	3300mm
重量(W)	36.2t

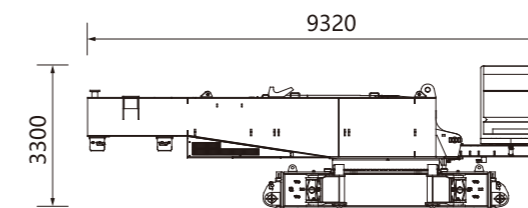

主机运输方案 B Basic machine transport plan B	×1
长(L)	9320mm
宽(W)	3000mm
高(H)	3300mm
重量(W)	29t

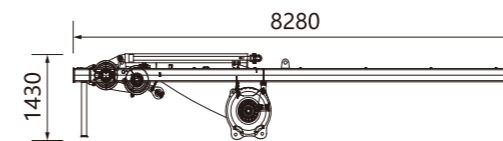

桅杆单独运输组件 Mast transport parts	×1
长(L)	8280mm
宽(W)	1660mm
高(H)	1430mm
重量(W)	7.2t

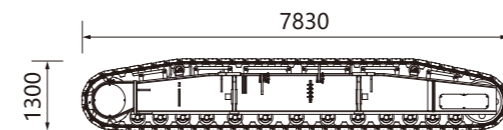

履带架 Track frame	×2
长(L)	7830mm
宽(W)	1400mm
高(H)	1300mm
重量(W)	16.2t

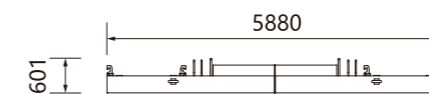

平衡重托盘 Counterweight tray	×1
长(L)	5880mm
宽(W)	1800mm
高(H)	601mm
重量(W)	18t



平衡重块 Counterweight	×2
长(L)	4400mm
宽(W)	1100mm
高(H)	410mm
重量(W)	3t

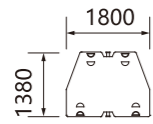

平衡重块 Counterweight	×8
长(L)	1800mm
宽(W)	1380mm
高(H)	566mm
重量(W)	5t

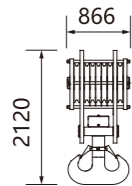

150t吊钩(选配) 150t hook block(Optional)	×1
长(L)	866mm
宽(W)	760mm
高(H)	2120mm
重量(W)	2.18t

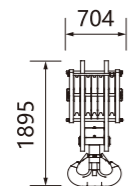

100t吊钩 100t hook block	×1
长(L)	704mm
宽(W)	760mm
高(H)	1895mm
重量(W)	1.67t

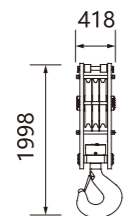

80t吊钩 80t hook block	×1
长(L)	418mm
宽(W)	760mm
高(H)	1998mm
重量(W)	0.95t

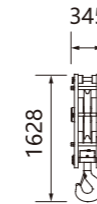

32t吊钩 32t hook block	×1
长(L)	354mm
宽(W)	760mm
高(H)	1628mm
重量(W)	0.7t

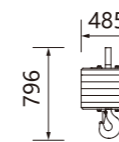

13.5t吊钩 13.5t hook block	×1
长(L)	485mm
宽(W)	485mm
高(H)	796mm
重量(W)	0.5t

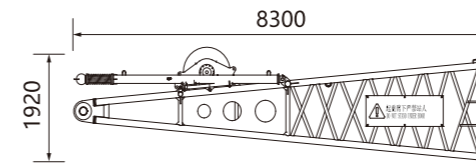

主臂底节臂 Boom butt	×1
长(L)	8300mm
宽(W)	2020mm
高(H)	1920mm
重量(W)	4.75t

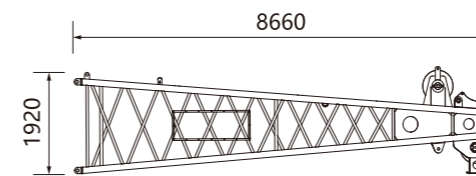

主臂顶节臂 Boom top	×1
长(L)	8660mm
宽(W)	2020mm
高(H)	1920mm
重量(W)	2.3t

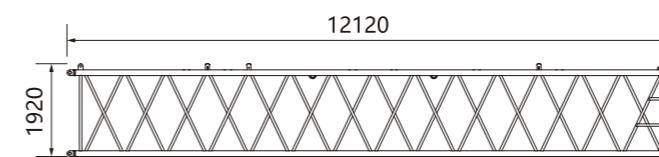

主臂12m中间节 12m boom insert section	×4
长(L)	12120mm
宽(W)	2020mm
高(H)	1920mm
重量(W)	1.54t

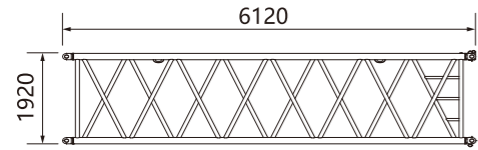

主臂6m中间节 6m boom insert section	×1
长(L)	6120mm
宽(W)	2020mm
高(H)	1920mm
重量(W)	0.84t

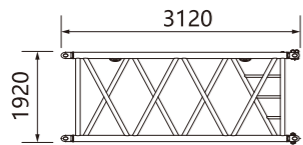

主臂3m中间节 3m boom insert section	×2
长(L)	3120mm
宽(W)	2020mm
高(H)	1920mm
重量(W)	0.5t

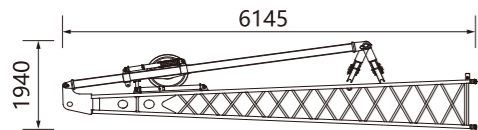

固定副臂底节 Fixed jib butt	×1
长(L)	6145mm
宽(W)	1245mm
高(H)	1940mm
重量(W)	0.9t

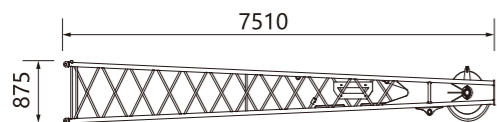

固定副臂顶节 Fixed jib top	×1
长(L)	7510mm
宽(W)	1065mm
高(H)	875mm
重量(W)	0.47t

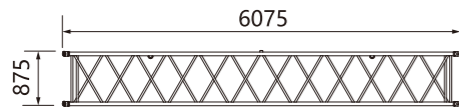

固定副臂中间节 Fixed jib insert section	×3
长(L)	6075mm
宽(W)	1065mm
高(H)	875mm
重量(W)	0.25t

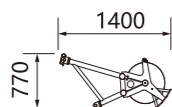

臂端单滑轮 Boom end pulley assembly	×1
长(L)	1400mm
宽(W)	1060mm
高(H)	770mm
重量(W)	0.16t

工作条件及注意 Working conditions and Cautions

工作条件及注意 Working conditions and Cautions

- 本起重机的工作条件为：臂长≤50m时风速小于13.8m/s,臂长>50m时风速小于8.3m/s,环境温度-20°C~+40°C,地面倾斜度小于1%。
The crane working conditions: boom length ≤ 50m when wind speed is less than 13.8m/s;boom length > 50m when wind speed is less than 8.3m/s;the ambient temperature is -20°C~+40°C; and the ground gradient is less than 1%.
- 表中额定起重量,指在给定的臂架长度、工作半径条件下,重物自由悬挂,在坚实、平坦地面作业所能保证的最大起重量。作业者须视各种不良条件(如地面松软或不平、风力、侧面负荷、摆动作用、多台起重机合力起吊等)限制或降低起重机的起重量。
The rated lifting load in the chart are the maximum lifting capacity on the condition that the given working conditions are met and the load is in the state of free suspension and lifted slowly from the solid ground.Operators should limit or reduce lifting capacity according to different conditions(such as soft or uneven ground,wind force,side loading,oscillating action,several crane cooperate-lifting).
- 表中额定起重量包括吊钩、钢丝绳和其他所有吊具的重量。
The rated lifting capacity in the chart includes the weight of main hook block,wire rope and all slings.
- 表中没有列出额定值的空白区,不允许起重机用于该区所对应的起重作业。
The blank area of the chart where no rated lifting load listed is regarded as non-operation area,so crawler crane is not allowed to carry out lifting operation in this area.
- 吊钩及倍率的选取,在任何情况下,吊钩的选取必须满足吊钩的额定起重量大于或等于实际吊重量(包括钢丝绳及吊具等),倍率按下表选取:
Selection of hook block and parts of line In any case,the selection of hook block must satisfy that the hook block rated lifting load is more than or equal to the actual lifting load (including wire rope,slings and etc.).

吊钩倍率的选取Parts of line is according to the table below:

倍率Parts of line	1	2	3	4	5	6	7	8	9	10	11	12	13	14
最大起重量/t Max.lifting load	13.5	25.6	37.8	49.7	61.2	72.4	83.2	93.7	103.9	113.8	123.4	132.7	141.7	150

单倍率用于臂端单滑轮。
The one part of line is used for boom single top.